

Specification

5050 RGB
5050 Single Chip RGB Color Top LED

Part No :



■ Features:

PLCC LED dimensions: 5.0(L) x 5.0(W) x 1.6(H) mm:

Wide view angle 120°

Available on tape and reel with Anti-electrostatic bag

Compatible for all SMT Assembly and Lead-Free Soldering
RoHS Compliant



■ Applications:

Backlight for LCD Switch and Display

Decorative Lighting

General Lighting

Automotive Interior Lighting

General Use

■ Package Dimensions:

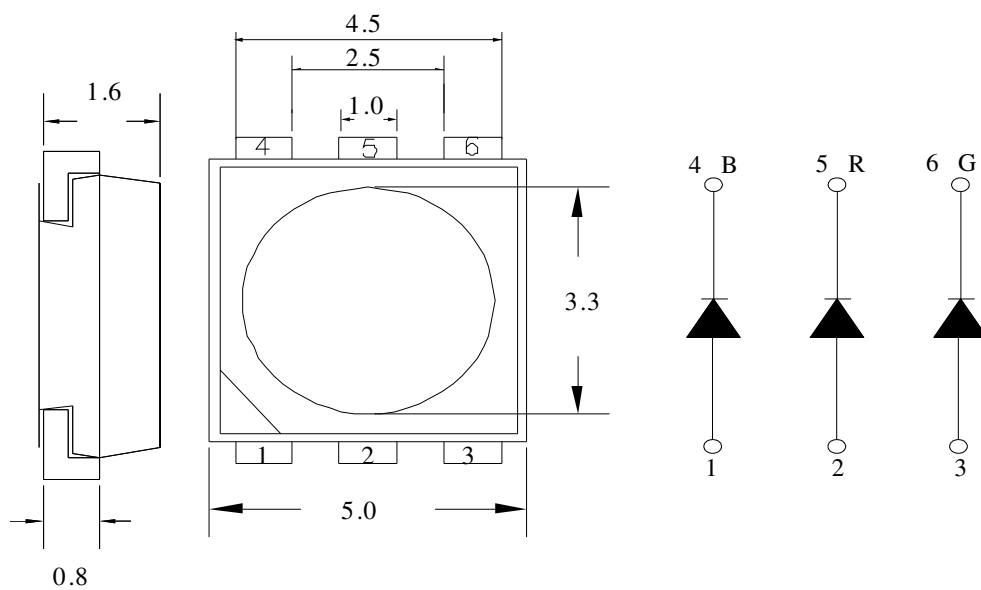

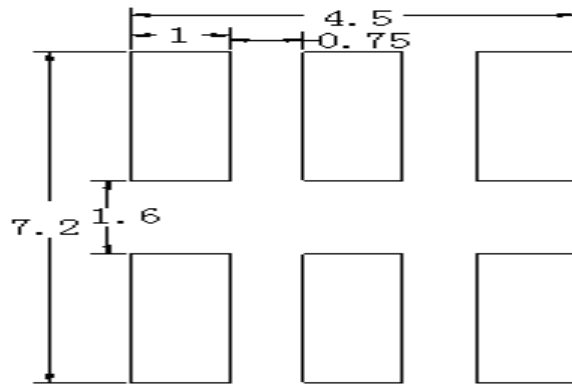

Recommended Soldering Pads Dimensions

■ Recommended Soldering Pads Dimensions

All dimension units are in millimeters.

All dimension tolerances are $\pm 0.25\text{mm}$ unless otherwise noted.

■ Absolute Maximum Ratings:

参数 Parameter	符号 Symbol	数值 Value	单位 Unit
功耗 Power dissipation	P_d	60	mW
连续正向电流 Continuous Forward Current	I_F	20	mA
峰值正向电流 (1/10 Duty Cycle, 0.1ms Pulse Width) Peak Forward Current	I_{FP}	50	mA
反向电压 Reverse Voltage	V_R	5	V
静电放电(HBM) Electrostatic Discharge (HBM)	ESD	1000	V
工作温度范围 Operating Temperature Range	T_{opr}	-25 to +85	$^{\circ}\text{C}$
存储温度范围 Storage Temperature Range	T_{stg}	-40 to +100	$^{\circ}\text{C}$
无铅焊接温度 Lead Soldering Temperature	T_{sol}	260(for 5 sec)	$^{\circ}\text{C}$

Electrical Optical Characteristics:

WW-FCE50TC-Q1(P)(SQ)

Parameter	Symbol	Min.	Typ.	Max.	Unit	Test Conditions
Luminous Intensity	LV(R)	400	---	600	mcd	$I_F = 20\text{mA}$
	LV(G)	1000	---	1200		
	LV(B)	300	---	400		
Spectral	$\lambda d_{(R)}$	620	---	630	nm	$I_F = 20\text{mA}$
	$\lambda d_{(G)}$	515	---	525		
	$\lambda d_{(B)}$	465	---	475		
Ref.Luminous Flux	Φ_v	---	---	---	Lm	$I_F = 20\text{mA}$
Viewing Angle	2 θ 1/2	---	120	---	Deg	$I_F = 20\text{mA}$
Forward Voltage	VF(R)	1.8	---	2.6	V	$I_F = 20\text{mA}$
	VF(G)	2.8	---	3.6		
	VF(B)	2.8	---	3.6		
Reverse Current	I_R	---	---	5	μA	$V_R = 5\text{V}$

Notes:

WW maintains a tolerance of $\pm 10\%$ on flux and power measurements.

$\lambda_d \pm 1\text{nm}$.

A tolerance of $\pm 0.1\text{V}$ on forward voltage measurements

Typical Optical Characteristics Curves

Forward Current vs Forward Voltage

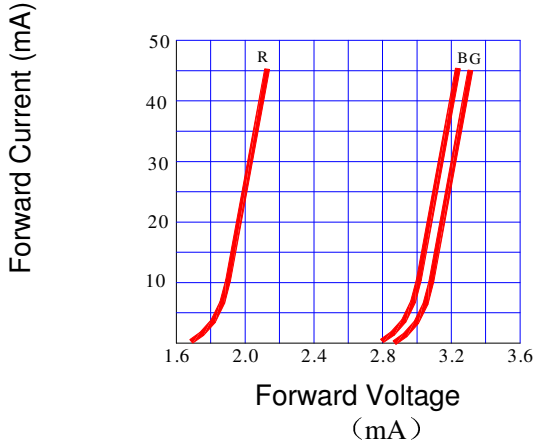

Forward Current vs Relative Luminous Intensity

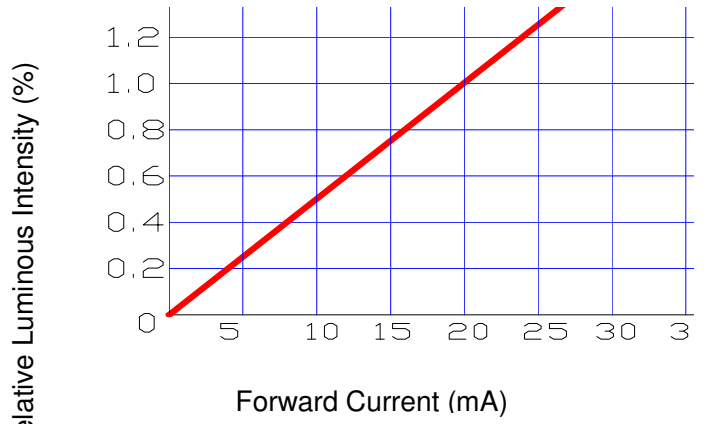

Spectral Distribution

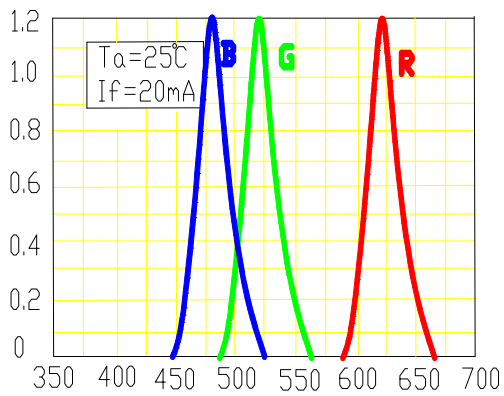

Luminous Intensity vs Ambient Temperature

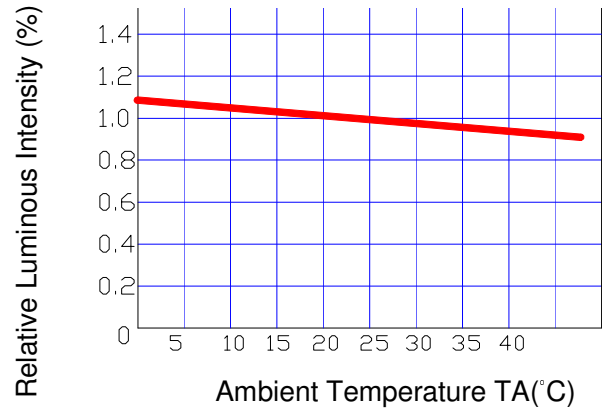

Radiation Diagram

Forward Current Derating Curve

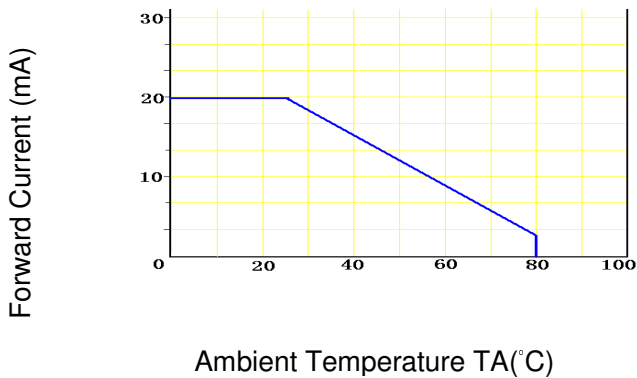

Radiation Diagram

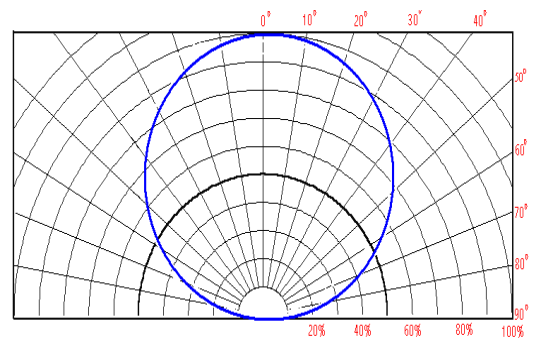

No.	Test Item	Standard Test Method	Test Conditions	Duration	Failure Rate
1	Steady State Operating Life	JEITA ED-4701 100 103	I _f =20mA T _a =25°C	1000hrs	0/22
2	Low Temperature Storage	JEITA ED-4701 200 202	T _a =-40°C	1000hrs	0/22
3	High Temperature Storage	JEITA ED-4701 200 201	T _a =100°C	1000hrs	0/22
4	Temperature Humidity Storage	JEITA ED-4701 100 103	T _a =60°C RH=90%	1000hrs	0/22
5	Thermal Shock	JEITA ED-4701 300 307	0°C ~ +100°C 5min~ 15sec ~ 5min	10 cycles	0/22
6	Temperature Cycle	JEITA ED-4701 100 105	H: +100°C 30min. ∫ : +25°C 5min. L: -40°C 30min	100 cycles	0/22
7	Solder Heat	JEITA ED-4701 300 301	T _{sld} =260°C, 10sec (Max.)	2 times	0/22

Item	Symbol	Test Condition	Min.	Max.
Forward Voltage	V _F	I _F = 20mA	--	*U.S.L×1.1
Reverse Current	I _R	V _R = 5V	--	*U.S.L×2.0
Luminous Intensity	I _v	I _F = 20mA	**L.S.L×0.7	--

*U.S.L.: Upper Standard Level

** L.S.L.: Lower Standard Level

■ Dimensions of the tape:

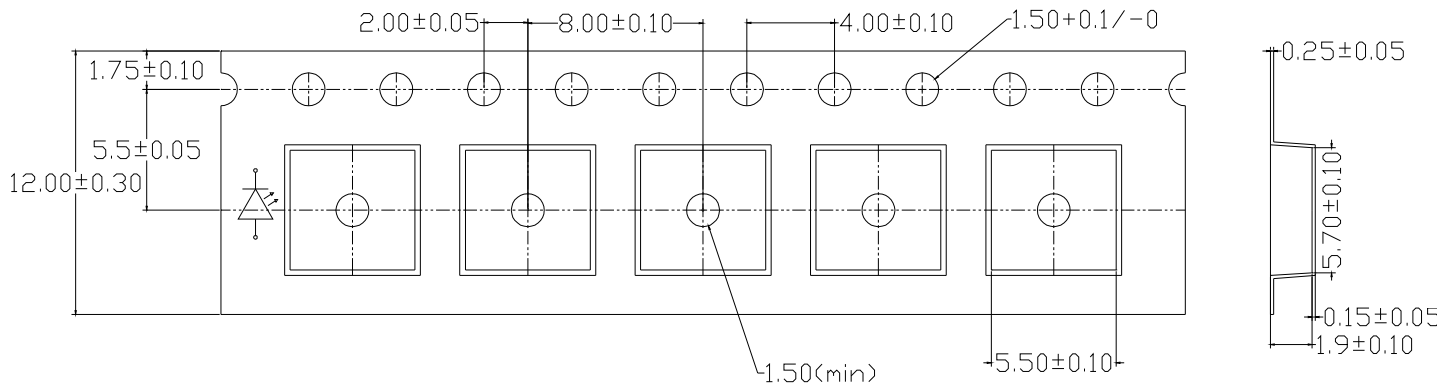

■ Dimensions of the reel:

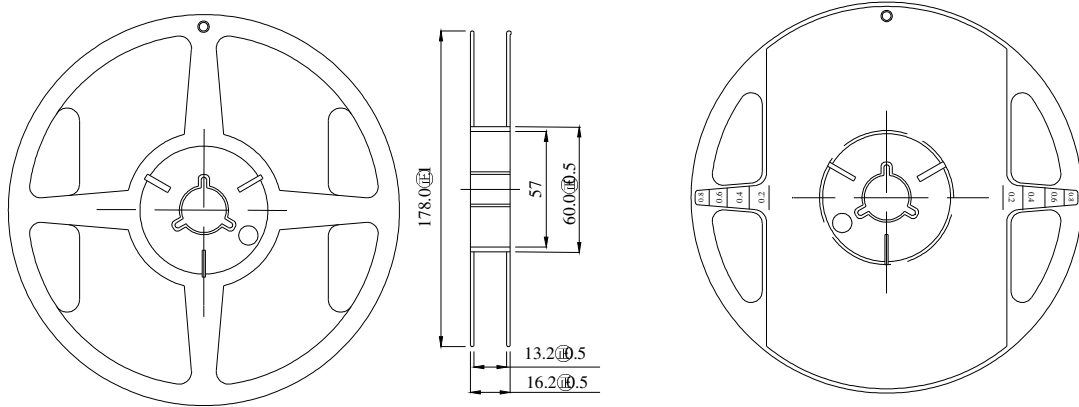

■ Packing:

■ Moisture, anti-static vacuum sealed packages

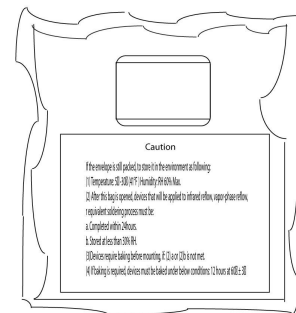
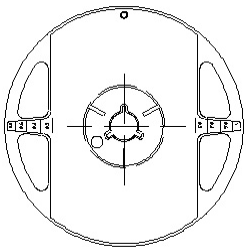

■ Note:

All dimensions are in mm, tolerance is $\pm 2.0\text{mm}$ unless otherwise noted.

Storage

Recommended storage environment

Temperature: 5°C ~ 30°C (41°F ~ 86°F)

Humidity: 60% RH Max.

Recommend the use of drying cabinet storage.

Recommended storage period is 1 month. Storage beyond such period requires baking treatment (as described below).

Use

Please check the Humidity indicator card after opening of sealed vapor/ESD (Picture 1.) If the 40% circle color is still blue, the product could normal use. Otherwise, 40% circle color is pink; please follow below Baking treatment before normal use.

Baking treatment : Open-static bag, the product and reel dial out from the Static bag, and then 75±5°C for 8 hours baking treatment.

All un-sealed products are recommended to be used within 12 hours (under a condition of ≤30°C, ≤60%RH). Seal all remaining products in time, recommend storage in dry cabinet storage. It must be baking treatment when using the remaining product.

Soldering

A. Reflow Process

Reflow Soldering		
	Lead Solder	Lead – free Solder
Pre-heat	120~150°C	180~200°C
Pre-heat time	120sec. Max.	120sec. Max.
Peak temperature	240°C Max.	260°C Max.
Soldering time	10sec. Max.	10sec. Max.
Condition	refer to Temperature-profile 1	refer to Temperature-profile 2

After reflow soldering rapid cooling should be avoided.

[Temperature-profile (Surface of circuit board)] Use the conditions shown to the under figure.

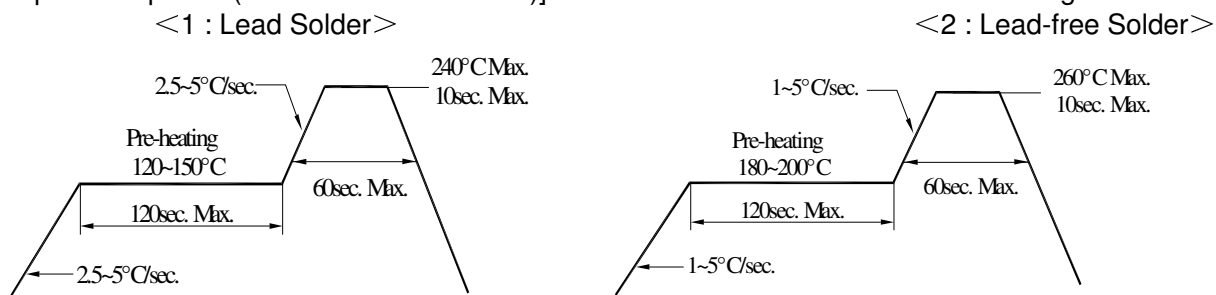

B. Manual Soldering Process

Hand Soldering	
Temperature	350°C Max.
Soldering time	3sec. Max. (one time only)

- For prototype builds or small series production runs it is possible to place and solder the LED by hand.
- Dispense thermal conductive glue or grease on the substrates and follow its curing specifications. Gently press LED housing to closely connect LED and substrate.
- It is recommended to hand solder the leads with a solder tip temperature of 280°C for less than 3 second, at a time with a soldering iron of less than 30W. Solder at intervals of two seconds or more.
- Take caution and be aware that damaged products are often a result of improper hand soldering technique.

Rework

1. Customer must finish rework within 5 sec under 260°C
2. The head of iron cannot touch the resin
3. Twin-head type is preferred.

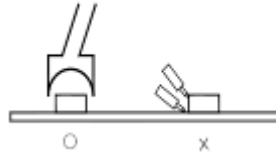

Cleaning :

The conditions of cleaning after soldering:

An alcohol-based solvent such as Isopropyl Alcohol(IPA) is recommended.

Temperature Time:<50°C *30sec,or <30°C *3min

Ultra sonic cleaning:<15W/bath; Bath volume:1liter max.

Curing:100 max,<3min

Cautions of Pick and Place:

It should be avoided to load stress on the resin during high temperature.

Avoid rubbing or scraping the resin by any object.

Electric-static may cause damage to the component. Please confirm that the equipment is grounding well. Using an ionizer fan is recommended.

Cautions of Design and Applications:

It should be done to connect with a current-limiting serial resistor. Avoid to drive reverse voltage over the specifications on LED when ON/OFF. Any application should refer to the specifications of absolute maximum ratings.

The dimensions of the recommended soldering pattern may not meet every users. Please confirm and study before designing the soldering pattern in order to obtain the best performance of soldering.

Do not contact with any component on the assembly board.

Static Electricity:

These products are so sensitive to static electricity charge so that all equipment and machinery must be properly grounded and it is recommended to use a wristband or anti-electrostatic glove when handling the SMD LED.

Particularly if any over-current and over-voltage which exceed the Absolute Maximum Ratings of LED applied, the more energy may cause damage or possibly result in electrical destruction of the Products.

A protection design should be installed in the LED driving circuit, which does not exceed the max. rating for surge current during on/off switching.

A tip if soldering iron is requested to be grounded .An ionizer should be installed when risk of static generation is high.

If the countermeasures mentioned above are implemented, LED can work well.

Users are required to check those countermeasures when problems occur by static electricity charge

Other:

Damaged SMD LED will show unusual characteristics such as leak current remarkably low current. Increase, turn-on voltage becomes lower and the SMD LED get unlighted at low current.

In automatic mounting of the SMD LEDs on printed circuit boards, any bending and pulling forces or shock against the SMD LEDs shall be kept min. to prevent them from expanding or electrical failures and mechanical damages of the devices.