

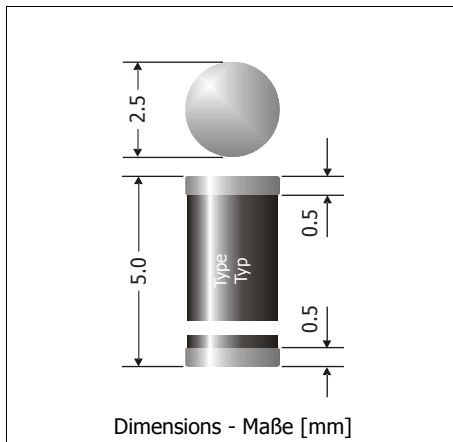

SMZ1 ... SMZ200 (2 W)

Surface Mount Silicon-Zener Diodes (non-planar technology) Flächendiffundierte Si-Zener-Dioden für die Oberflächenmontage

Version 2012-04-02



Maximum power dissipation Maximale Verlustleistung	2 W
Nominal Z-voltage Nominale Z-Spannung	1...200 V
Plastic case MELF Kunststoffgehäuse MELF	DO-213AB
Weight approx. – Gewicht ca.	0.12 g
Plastic material has UL classification 94V-0 Gehäusematerial UL94V-0 klassifiziert	
Standard packaging taped and reeled Standard Lieferform gegurtet auf Rolle	

Standard Zener voltage tolerance is graded to the international E 24 ($\sim \pm 5\%$) standard.
Other voltage tolerances and higher Zener voltages on request.

Die Toleranz der Zener-Spannung ist in der Standard-Ausführung gestuft nach der internationalen Reihe E 24 ($\sim \pm 5\%$). Andere Toleranzen oder höhere Arbeitsspannungen auf Anfrage.

Maximum ratings and Characteristics

Grenz- und Kennwerte

		SMZ-series	
Power dissipation Verlustleistung	$T_A = 50^\circ\text{C}$	P_{tot}	2 W ¹⁾
Non repetitive peak power dissipation, $t < 10$ ms Einmalige Impuls-Verlustleistung, $t < 10$ ms	$T_A = 25^\circ\text{C}$	P_{ZSM}	60 W
Max. operating junction temperature – Max. Sperrschichttemperatur Storage temperature – Lagerungstemperatur		T_j T_s	+150°C -50...+175°C
Thermal resistance junction to ambient air Wärmewiderstand Sperrschicht – umgebende Luft		R_{thA}	<45 K/W ¹⁾
Thermal resistance junction to terminal Wärmewiderstand Sperrschicht – Anschluss		R_{thT}	<15 K/W
Zener voltages see table on next page – Zener-Spannungen siehe Tabelle auf der nächsten Seite			

1 Mounted on P.C. board with 50 mm² copper pads at each terminal
Montage auf Leiterplatte mit 50 mm² Kupferbelag (Lötpad) an jedem Anschluss

2 Tested with pulses – Gemessen mit Impulsen

3 The SMZ1 is a diode operated in forward mode. Hence, the index of all parameters should be "F" instead of "Z".
The cathode, indicated by a white band, has to be connected to the negative pole.
Die SMZ1 ist eine in Durchlass betriebene Si-Diode. Daher ist bei allen Kenn- und Grenzwerten der Index "F" anstatt "Z" zu setzen. Die mit weißem Balken gekennzeichnete Kathode ist mit dem Minuspol zu verbinden.

Maximum ratings
Grenzwerte

Type Typ	Zener voltage ²⁾ Zener-Spannung ²⁾ $I_Z = I_{Ztest}$		Test current Meßstrom I_{Ztest} [mA]	Dynamic resistance Diff. Widerstand $I_{Ztest} / f = 1 \text{ kHz}$ r_{zi} [Ω]	Temp. Coeffiz. of Z-voltage ...der Z-Spannung α_{vZ} [$10^{-4} / ^\circ\text{C}$]	Reverse volt. Sperrspanng. $I_R = 1 \mu\text{A}$ V_R [V]	Z-current ¹⁾ Z-Strom ¹⁾ $T_A = 50^\circ\text{C}$ I_{Zmax} [mA]
	V_{zmin} [V]	V_{zmax} [V]					
SMZ1 ³⁾	0.71	0.82	100	0.5 (<1)	-26...-16	-	1200
SMZ5.6	5.2	6.0	100	1 (<3)	-3...+5	> 0.5 / 3 μA	333
SMZ6.2	5.8	6.6	100	1 (<2)	-1...+6	> 1.5	303
SMZ6.8	6.4	7.2	100	1 (<2)	0...+7	> 2	278
SMZ7.5	7.0	7.9	100	1 (<2)	0...+7	> 2	253
SMZ8.2	7.7	8.7	100	1 (<2)	+3...+8	> 3.5	230
SMZ9.1	8.5	9.6	50	2 (<4)	+3...+8	> 3.5	208
SMZ10	9.4	10.6	50	2 (<4)	+5...+9	> 5	189
SMZ11	10.4	11.6	50	4 (<7)	+5...+10	> 5	172
SMZ12	11.4	12.7	50	4 (<7)	+5...+10	> 7	157
SMZ13	12.4	14.1	50	5 (<10)	+5...+10	> 7	142
SMZ15	13.8	15.6	50	5 (<10)	+5...+10	> 10	128
SMZ16	15.3	17.1	25	6 (<15)	+6...+11	> 10	117
SMZ18	16.8	19.1	25	6 (<15)	+6...+11	> 10	105
SMZ20	18.8	21.2	25	6 (<15)	+6...+11	> 10	94
SMZ22	20.8	23.3	25	6 (<15)	+6...+11	> 12	86
SMZ24	22.8	25.6	25	7 (<15)	+6...+11	> 12	78
SMZ27	25.1	28.9	25	7 (<15)	+6...+11	> 14	69
SMZ30	28	32	25	8 (<15)	+6...+11	> 14	63
SMZ33	31	35	25	8 (<15)	+6...+11	> 17	57
SMZ36	34	38	10	16 (<40)	+6...+11	> 17	53
SMZ39	37	41	10	20 (<40)	+6...+11	> 20	49
SMZ43	40	46	10	24 (<45)	+7...+12	> 20	43
SMZ47	44	50	10	24 (<45)	+7...+12	> 24	40
SMZ51	48	54	10	25 (<60)	+7...+12	> 24	37
SMZ56	52	60	10	25 (<60)	+7...+12	> 28	33
SMZ62	58	66	10	25 (<80)	+8...+13	> 28	30
SMZ68	64	72	10	25 (<80)	+8...+13	> 34	28
SMZ75	70	79	10	30 (<100)	+8...+13	> 34	25
SMZ82	77	88	10	30 (<100)	+8...+13	> 41	23
SMZ91	85	96	5	40 (<200)	+9...+13	> 41	21
SMZ100	94	106	5	60 (<200)	+9...+13	> 50	19
SMZ110	104	116	5	80 (<250)	+9...+13	> 50	17
SMZ120	114	127	5	80 (<250)	+9...+13	> 60	16
SMZ130	124	141	5	90 (<300)	+9...+13	> 60	14
SMZ150	138	156	5	100 (<300)	+9...+13	> 75	13
SMZ160	153	171	5	110 (<350)	+9...+13	> 75	12
SMZ180	168	191	5	120 (<350)	+9...+13	> 90	10
SMZ200	188	212	5	150 (<350)	+9...+13	> 90	9

1 Notes see previous page – Fußnoten siehe vorhergehende Seite

SMZ1 ... SMZ200 (2 W)

