

SANYO

No. 2668A

STK4132II

2ch AF Power Amplifier (Split Power Supply)
20W + 20W, THD = 1%

Features

- Pin compatible with the STK4102II and STK4101V series (high-grade type) over the output range 6 to 50W for easy interchangeability
- Small-sized package with the same pin assignment as the STK4101II series
- Built-in muting circuit to cut off spurious shock noise
- 125°C guaranteed high temperature operation allows greatly reduced heat sink size
- Excellent low-cost performance

Package Dimensions

unit: mm

4083

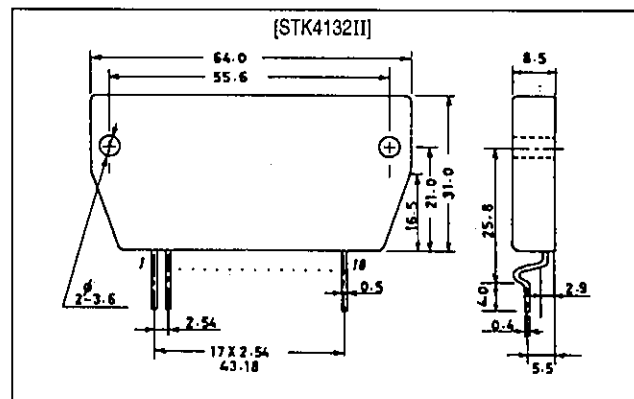

Specifications

Maximum Ratings at $T_a = 25^\circ\text{C}$

Parameter	Symbol	Conditions	Ratings	Unit
Maximum supply voltage	$V_{CC \text{ max}}$		± 34.5	V
Thermal resistance	θ_{j-c}		3.0	$^\circ\text{C/W}$
Junction temperature	T_j		150	$^\circ\text{C}$
Operating substrate temperature	T_c		125	$^\circ\text{C}$
Storage temperature	T_{stg}		-30 to +125	$^\circ\text{C}$
Available time for load short-circuit	t_s	$V_{CC} = \pm 23\text{V}$, $R_L = 8\Omega$, $f = 50\text{Hz}$, $P_O = 20\text{W}$	2	s

Recommended Operating Conditions at $T_a = 25^\circ\text{C}$

Parameter	Symbol	Conditions	Ratings	Unit
Supply voltage	V_{CC}		± 23	V
Load Impedance	R_L		8	Ω

SANYO Electric Co., Ltd. Semiconductor Business Headquarters
 TOKYO OFFICE Tokyo Bldg., 1-10, 1 Chome, Ueno, Taito-ku, TOKYO, 110 JAPAN

STK4132II

Operating Characteristics at $T_a = 25^\circ\text{C}$, $V_{CC} = \pm 23\text{V}$, $R_L = 8\Omega$ (noninductive load), $R_g = 600\Omega$, $V_G = 40\text{dB}$

Parameter	Symbol	Conditions	min	typ	max	Unit
Quiescent current	I_{CCO}	$V_{CC} = \pm 28\text{V}$	20	40	100	mA
Output power	$P_{O(1)}$	THD = 0.4%, $f = 20\text{Hz to } 20\text{kHz}$	20	-	-	W
	$P_{O(2)}$	$V_{CC} = \pm 20\text{V}$, THD = 1.0%, $R_L = 4\Omega$, $f = 1\text{kHz}$	20	-	-	W
Total harmonic distortion	THD	$P_O = 1.0\text{W}$, $f = 1\text{kHz}$	-	-	0.3	%
Frequency response	f_L, f_H	$P_O = 1.0\text{W}$, $_{-3}^{+0}\text{dB}$	-	20 to 50k	-	Hz
Input impedance	r_i	$P_O = 1.0\text{W}$, $f = 1\text{kHz}$	-	55	-	$k\Omega$
Neutral voltage	V_N	$V_{CC} = \pm 50.5\text{V}$	-70	0	+70	mV
Output noise voltage	V_{No}	$V_{CC} = \pm 28\text{V}$, $R_g = 10k\Omega$	-	-	1.2	mVrms
Muting voltage	V_M		-2	-5	-10	V

Notes.

All tests are measured using a constant-voltage supply unless otherwise specified.

Available time for load short-circuit and output noise voltage are measured using the transformer supply specified below.

The output noise voltage is the peak value of an average-reading meter with an rms value scale (VTVM). A regulated AC supply (50Hz) should be used to eliminate the effects of AC primary line flicker noise.

Specified Transformer Supply (RP-25 or Equivalent)

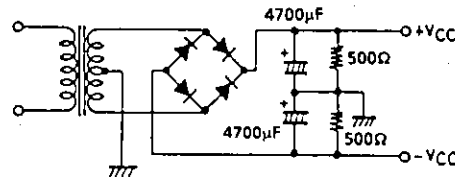

Equivalent Circuit

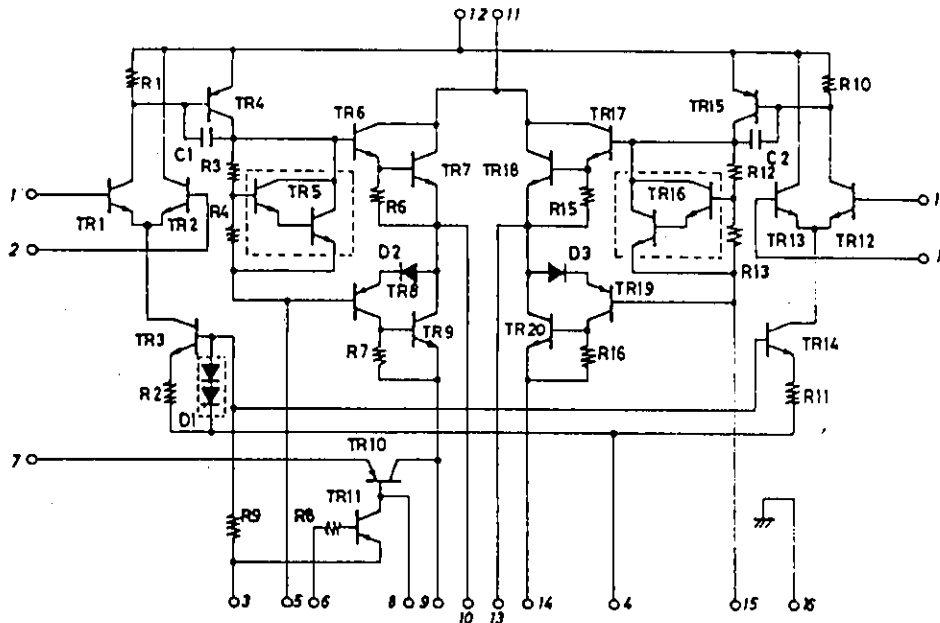

STK4132II

Sample Application Circuit (20W min, 2-Channel, AF Power Amplifier)

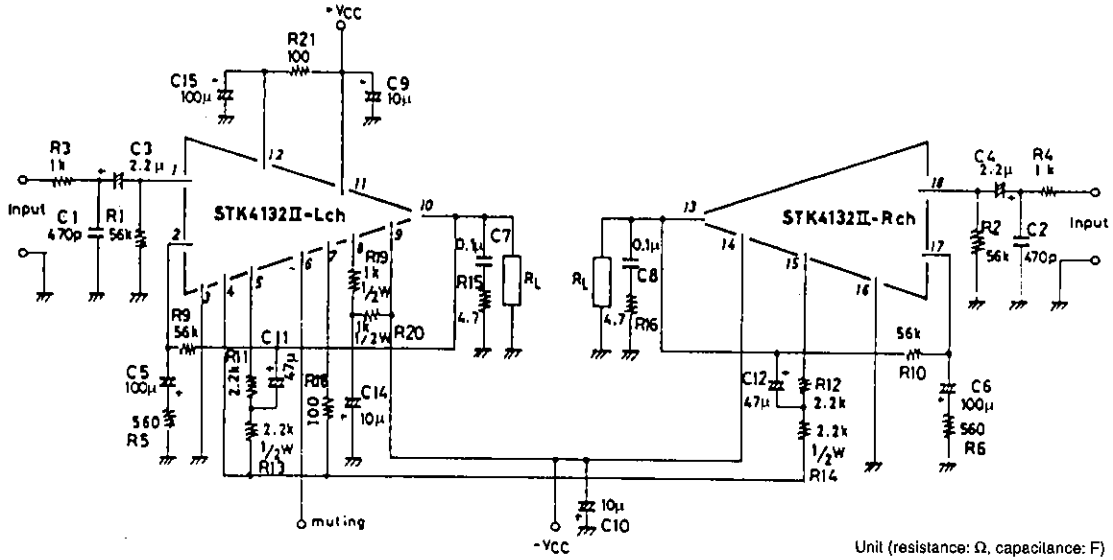

Sample Application Circuit PCB Layout (Copper Foil Surface)

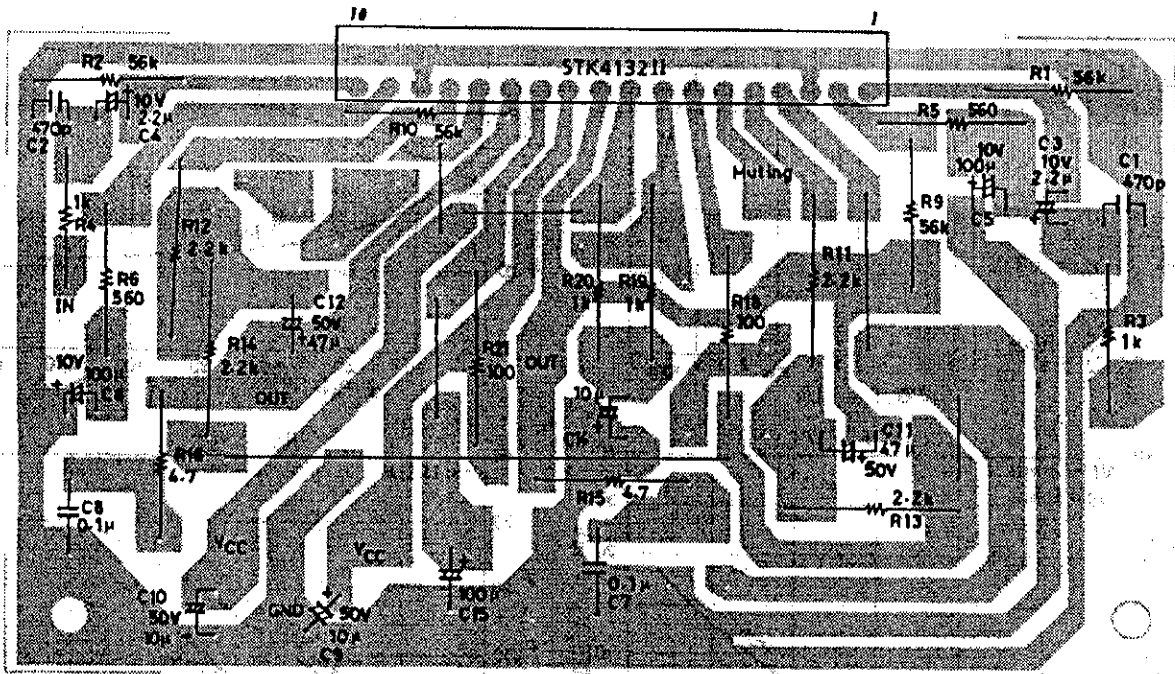

50 × 100mm²
Unit (resistance: Ω; capacitance: F)

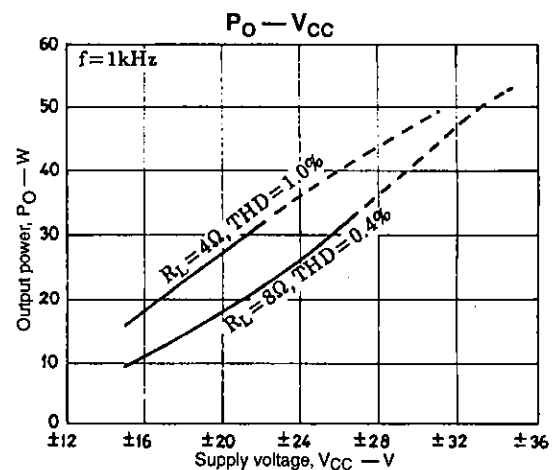
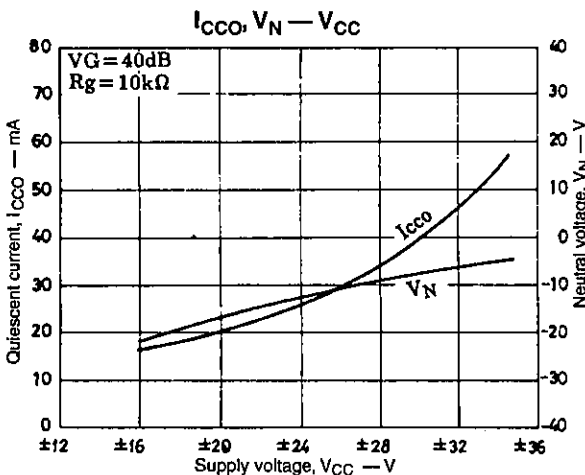
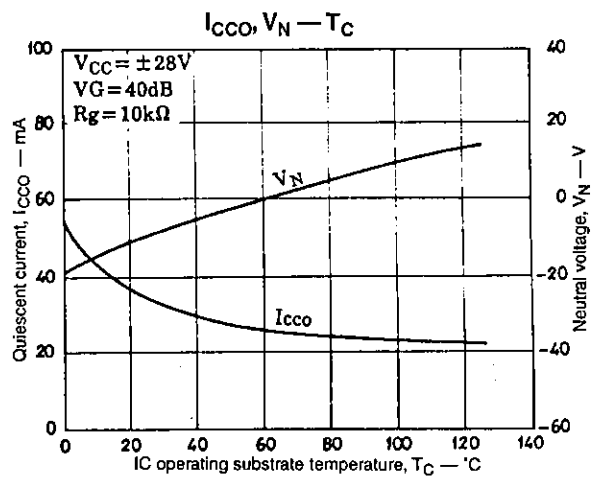
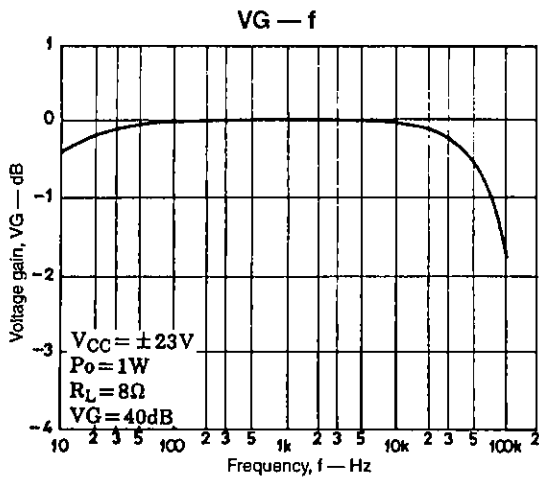
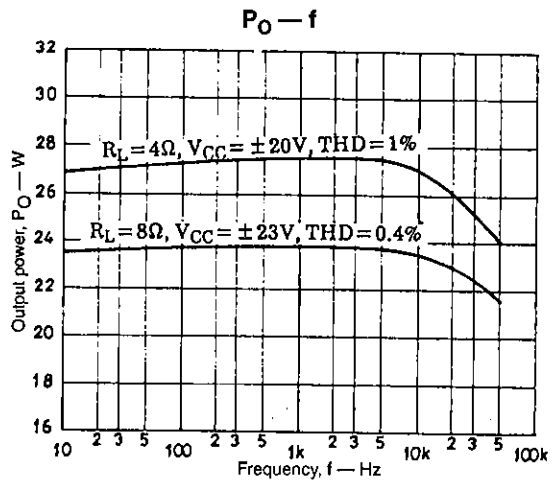
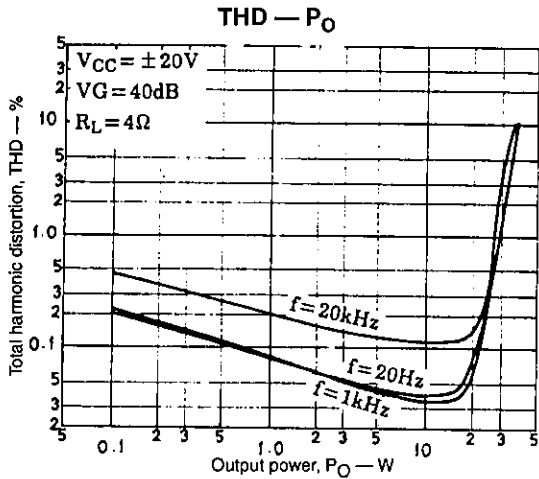
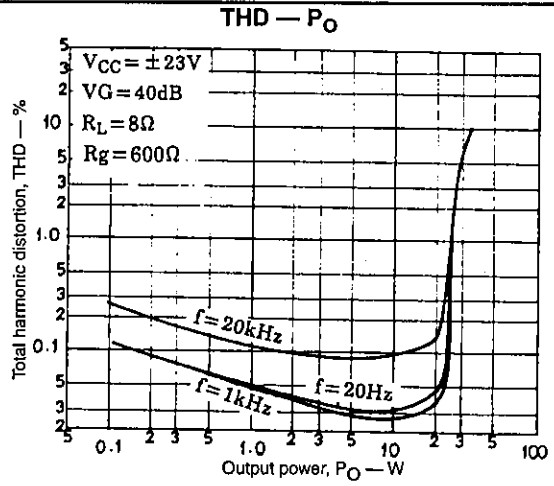
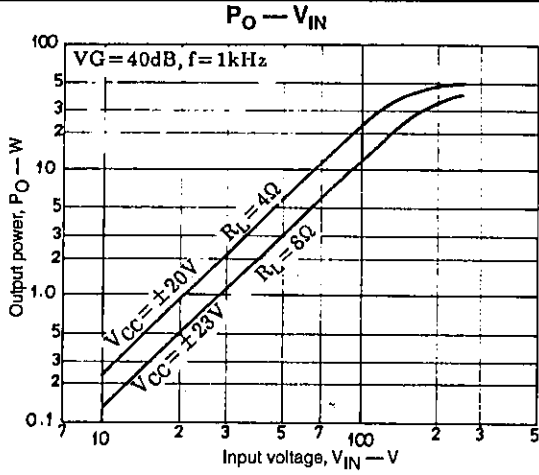

STK4132II

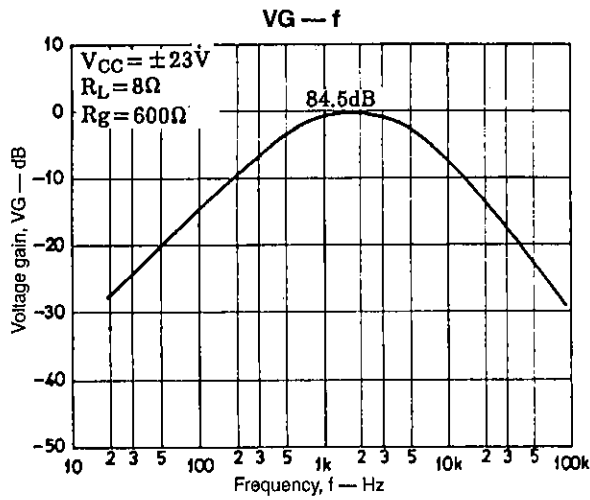
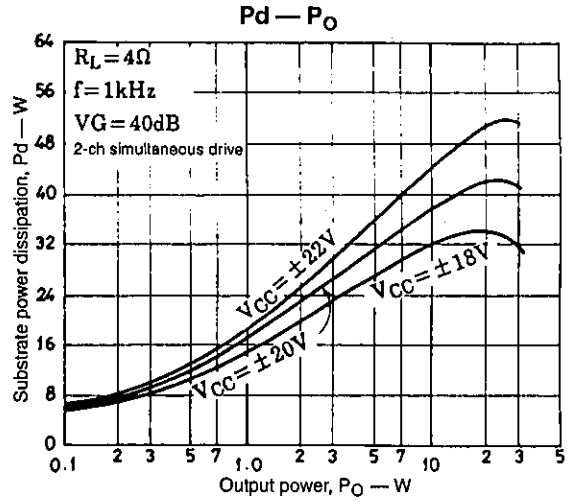
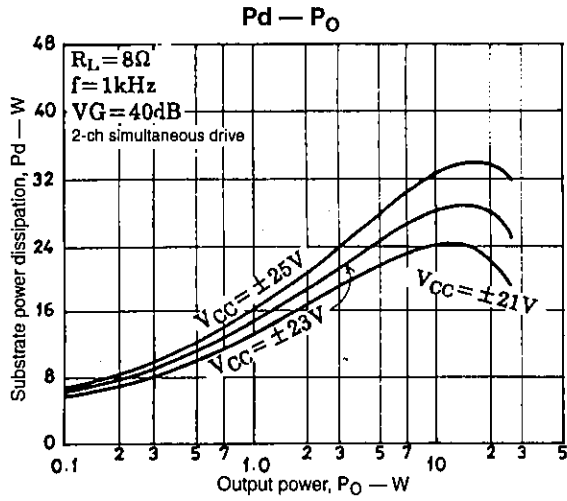

External Component Description

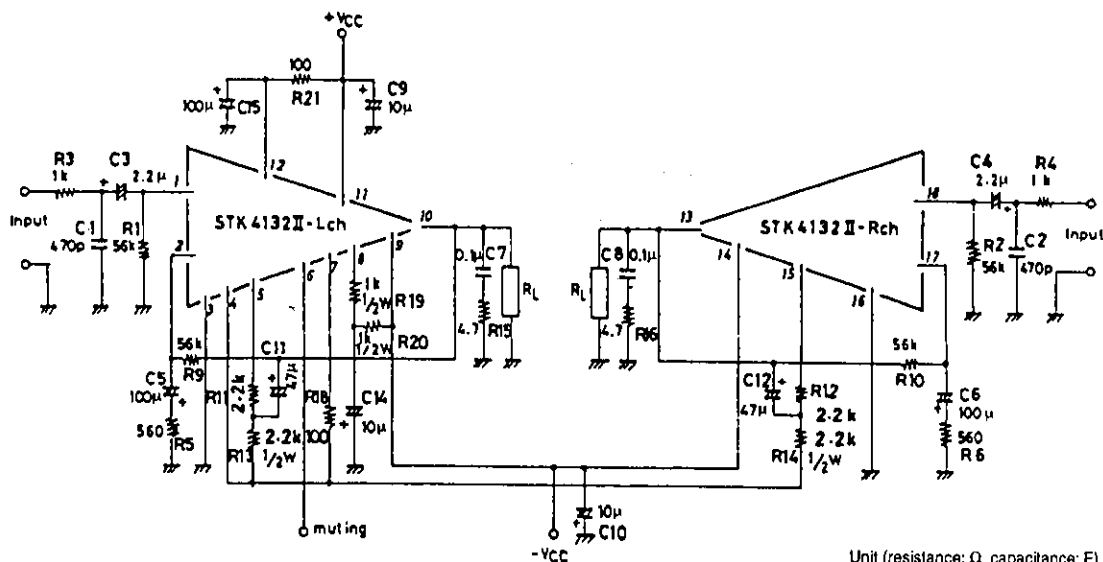

C1, C2	Input filter capacitors. These, together with R3 and R4, form filters to reduce high-band noise.
C3, C4	Input coupling capacitors. For DC blocking. Since capacitor reactance becomes larger at lower frequencies, the output noise can be adversely affected by signal source resistance-dependent 1/f noise. In this case, a lower reactance value should be chosen. In order to remove pop noise at power-on, larger values of capacitance should be chosen for C3 and C4, which determine the input time constant, and smaller values for C5 and C6 in the NF circuit.
C5, C6	NF capacitors. These determine the low-side cut-off frequency. $f_L = \frac{1}{2\pi \times C5 \times R5} \text{ [Hz]}$ A large value should be chosen for C5 to maintain voltage gain at low frequencies. However, because this would tend to increase the shock noise at power-on, a value larger than absolutely necessary should be avoided.
C15	Decoupling capacitors. This removes shock noise and ripple voltage from the supply.
C11, C12	Bootstrap capacitors. If these capacitors are made small, then the total harmonic distortion at low frequencies increases significantly.
C9, C10	Oscillation prevention capacitors. These should be inserted as close as possible to the IC supply pins to reduce supply impedance and hence provide stable IC operation. Electrolytic capacitors are recommended.
C14	Ripple filter capacitor. This forms a ripple filter in combination with internal transistor TR10.
C7	Oscillation prevention capacitor. Mylar capacitors are recommended for their excellent thermal and frequency characteristics.
R3, R4	Input filter resistors.
R1, R2	Input bias resistors. These are used to bias the input pins at zero potential. The input impedance is largely determined by this resistance.
R5, R9 (R6, R10)	Voltage-gain VG setting resistors. VG = 40dB is recommended using R5, R6 = 560Ω, and R9, R10 = 56kΩ. Gain adjustments are best made using R5 or R6. If gain adjustments are made using R5 or R6, then set R1, R2 = R9, R10 to maintain V _N balance stability.
R11, R13 (R12, R14)	Bootstrap resistors. These resistors determine the quiescent current. Values of 2.2kΩ and 2.2kΩ are recommended.
R21	Ripple filter resistor. This resistor performs as predriver transistor limiting resistor during load short circuits.
R18	Clipping plus/minus balance resistor.
R19, R20	Ripple filter resistors. When muting transistor TR11 is on, current flows from ground through TR11 to -V _{CC} . Values of 1kΩ (0.5W) and 1kΩ (0.5W) are recommended.
R15, R16	Oscillation prevention resistors.

Sample Application Circuit (Protection and Muting Circuit)

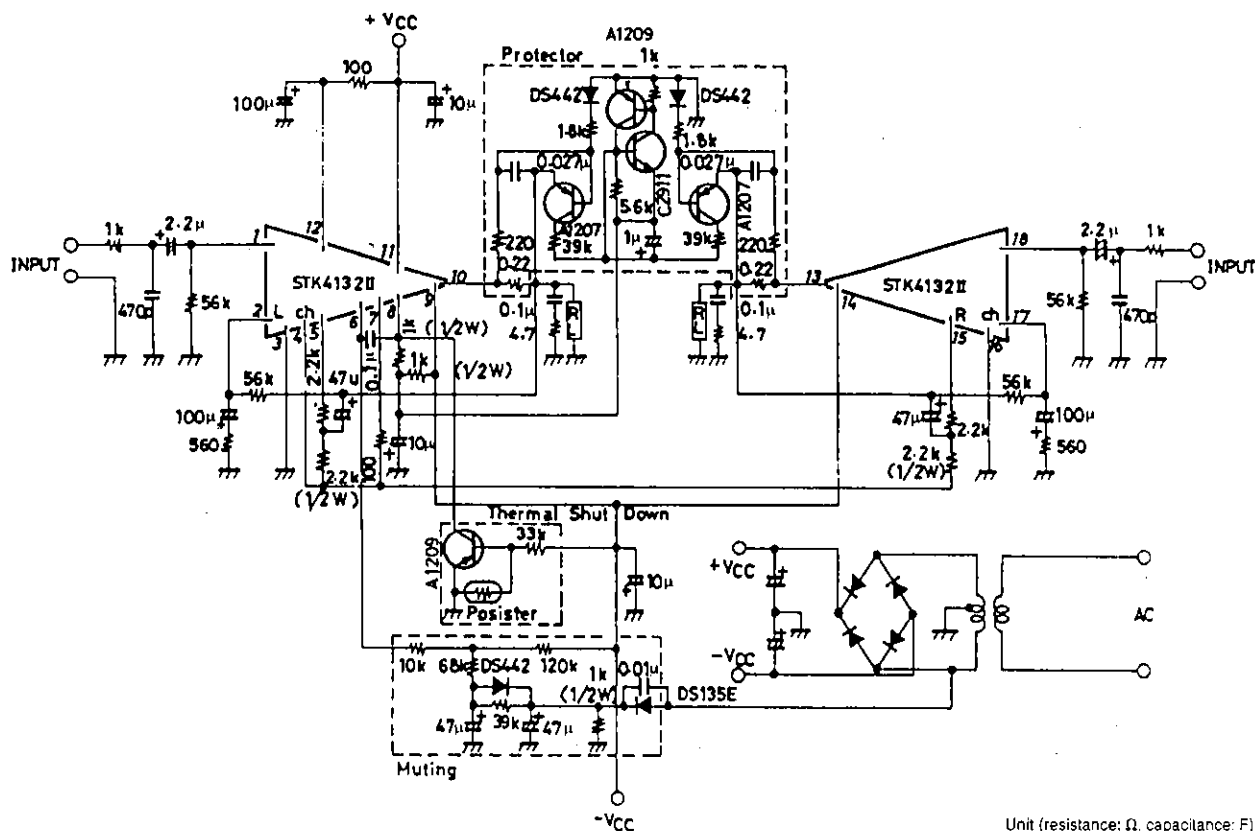

Heatsink Design

The total STK4132II device power dissipation for a continuous sine wave signal is shown in figures 1 and 2. The maximum dissipation is 29.2W for $R_L = 8\Omega$, and 42.8W for $R_L = 4\Omega$ (2-channel simultaneous drive).

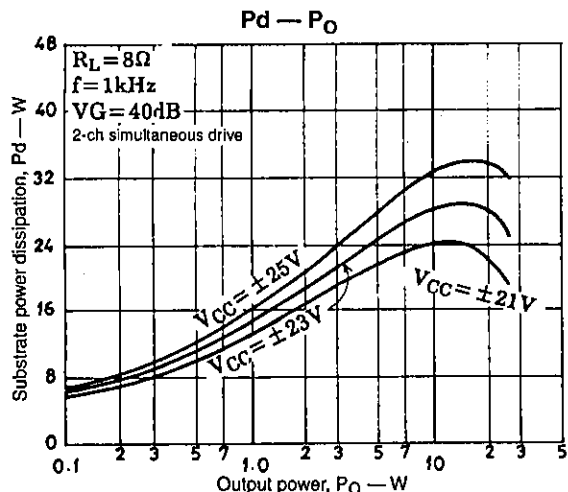

Figure 1. Pd — P_O ($R_L = 8\Omega$)

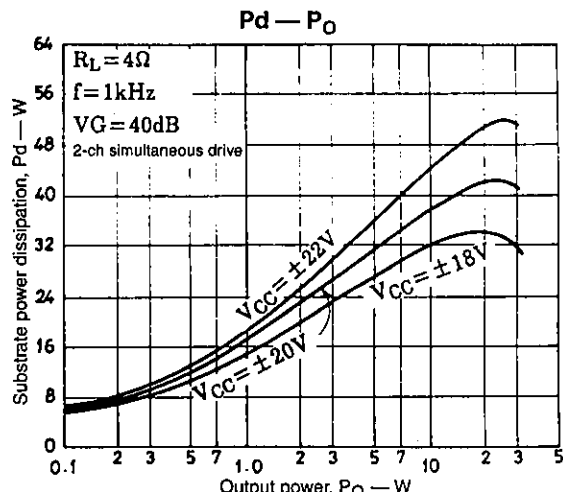

Figure 2. Pd — P_O ($R_L = 4\Omega$)

When estimating the power dissipation for an actual audio signal input, the rule of thumb is to select Pd corresponding to $(1/10) \times P_O \text{ max}$ (within safe limits) for a continuous sine wave input. For example,

$$Pd = 18.6W \text{ for } 8\Omega, \text{ and } Pd = 23W \text{ for } 4\Omega$$

The heatsink thermal resistance, θ_{c-a} , required to dissipate the STK4132II device total power dissipation, Pd, is determined as follows:

Condition 1: IC substrate temperature not to exceed 125°C.

$$T_C = Pd \times \theta_{c-a} + T_a \leq 125^\circ\text{C} \dots\dots\dots (1)$$

where Ta is the guaranteed maximum ambient temperature.

Condition 2: Power transistor junction temperature, Tj, not to exceed 150°C.

$$T_j = Pd \times \theta_{c-a} + Pd/4 \times \theta_{j-c} + T_a \leq 150^\circ\text{C} \dots\dots\dots (2)$$

The STK4132II has 4 power transistors (2 per channel), and the thermal resistance per transistor, θ_{j-c} , is 3.0°C/W. Therefore, equation 2 becomes:

$$Pd \times (\theta_{c-a} + 3.0/4) + T_a \leq 150^\circ\text{C} \dots\dots\dots (3)$$

The required heatsink must have a thermal resistance that satisfies both expressions 1 and 3. Figure 3 shows the ambient temperature parameter against Pd and θ_{c-a} calculated from equations 1 and 3.

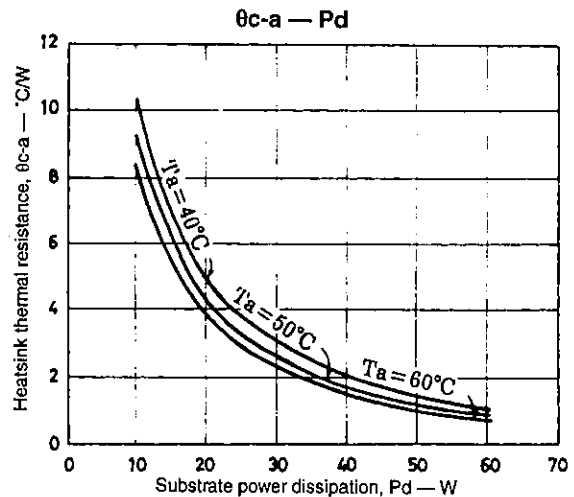

Figure 3. $\theta_{c-a} — Pd$

For example, a stereo amplifier with ambient temperature of $T_a = 50^\circ\text{C}$ needs a heatsink with thermal resistance given by the following:

For $V_{CC} = \pm 23V, R_L = 8\Omega$:

$1/10 P_O \text{ max}$ corresponds to $Pd1 = 18.6W$

From figure 3, the STK4132II thermal resistance is $\theta_{c-a1} = 4.04^\circ\text{C/W}$

From equation 3, this results in a junction temperature $T_j = 139.1^\circ\text{C}$.

For $V_{CC} = \pm 20V, R_L = 4\Omega$:

$1/10 P_O \text{ max}$ corresponds to $Pd2 = 23W$

From figure 3, the STK4132II thermal resistance is $\theta_{c-a2} = 3.26^\circ\text{C/W}$

From equation 3, this results in a junction temperature $T_j = 142.3^\circ\text{C}$.

- No products described or contained herein are intended for use in surgical implants, life-support systems, aerospace equipment, nuclear power control systems, vehicles, disaster/crime-prevention equipment and the like, the failure of which may directly or indirectly cause injury, death or property loss.
- Anyone purchasing any products described or contained herein for an above-mentioned use shall:
 - ① Accept full responsibility and indemnify and defend SANYO ELECTRIC CO., LTD., its affiliates, subsidiaries and distributors and all their officers and employees, jointly and severally, against any and all claims and litigation and all damages, cost and expenses associated with such use;
 - ② Not impose any responsibility for any fault or negligence which may be cited in any such claim or litigation on SANYO ELECTRIC CO., LTD., its affiliates, subsidiaries and distributors or any of their officers and employees, jointly or severally.
- Information (including circuit diagrams and circuit parameters) herein is for example only; it is not guaranteed for volume production. SANYO believes information herein is accurate and reliable, but no guarantees are made or implied regarding its use or any infringements of intellectual property rights or other rights of third parties.