

D-Sub in SMD-Technik

D-Sub in SMD technique

Connecteur types SUB-D

- Standard Steckbild
- platzsparende SMT-Anschlüsse
- mit Platinen-Clip

- Standard insertion pattern
- Space-saving SMT connections
- with board-clip

- version standard
- version haute densité (type SMT)
- version avec clips pour platine

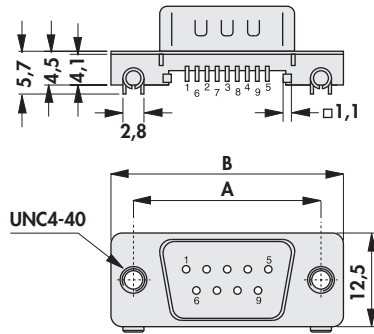

Art. Nr. Art. No. Art. n°	Polzahl No. of contacts Nbr. de contacts	A	B
DS 09 LSMD	9	25	30,9

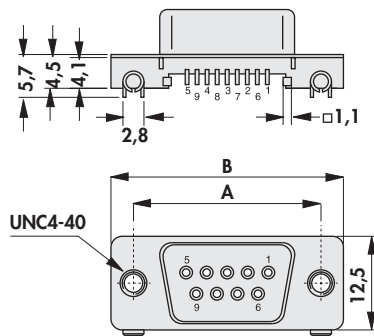
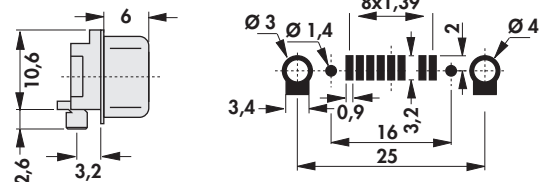

Art. Nr. Art. No. Art. n°	Polzahl No. of contacts Nbr. de contacts	A	B
DB 09 LSMD	9	25	30,9

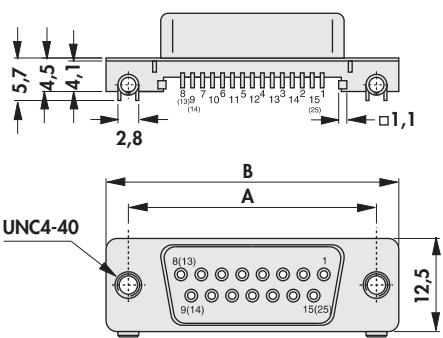
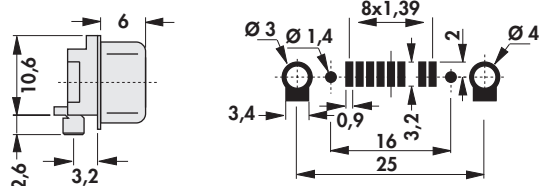

Art. Nr. Art. No. Art. n°	Polzahl No. of contacts Nbr. de contacts	A	B
DB 15 LSMD	15	33,3	39,3
DB 25 LSMD	25	47	53,1

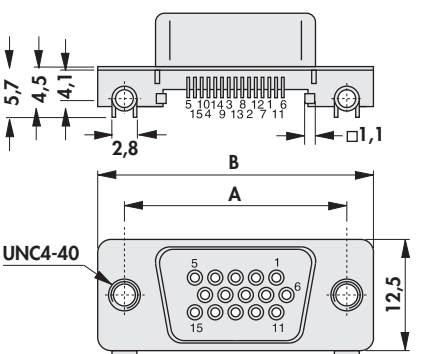
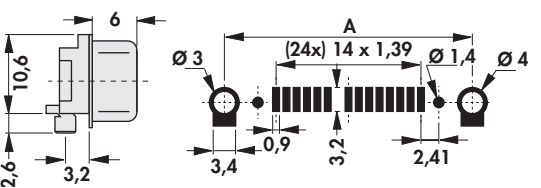

Art. Nr. Art. No. Art. n°	Polzahl No. of contacts Nbr. de contacts	A	B
HDB 15 L SMD	15	25	30,9

