

D-SUB right angled version. A wide range of mounting accessories is available. US and european standard.

Through hole 8,10 mm

Gender	Female
No of contacts	15
Plating shell	Ni
Material contact	Copper alloy
Plating contact	Selective Au
Mounting option DSUB	NB - Rivet + jack screw 11,80 mm attached

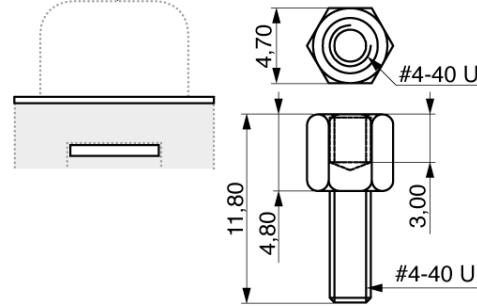

Colour	Black
Material insulator	Thermoplast UL94V-0
Rated current	5,0 A
Rated voltage	125 VRMS / Vdc
Withstand voltage	500 VRMS for 1 minute
Operating temperature	-55°C to +85°C
Max. processing temper.	230°C for 10 seconds
Packaging	Standard
A	39,14
B	33,32
C	25,50
D	24,66
E	-

