

PCB MAX SIZE

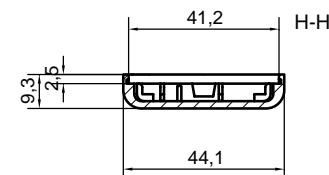

www.ret.hu
elektronika
Tel: +36 62 554-980

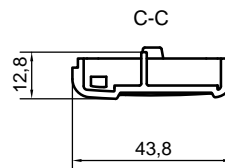
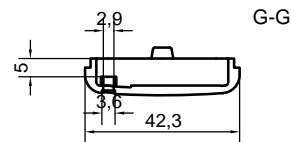
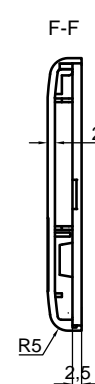
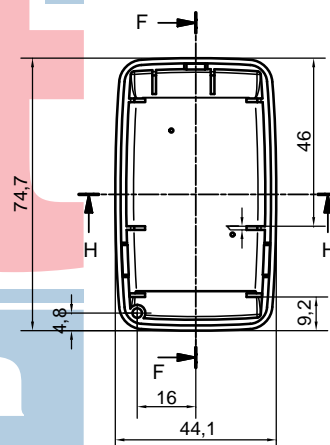
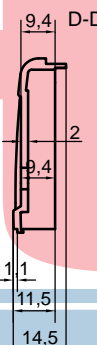
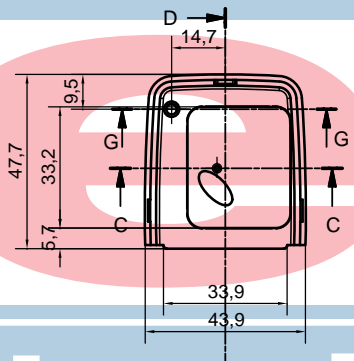
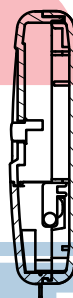
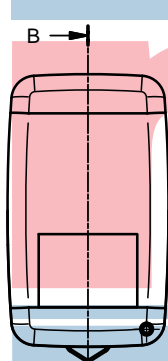
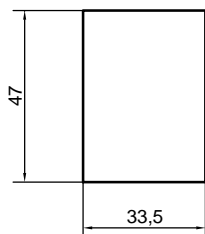
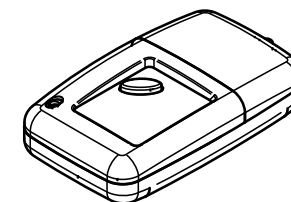
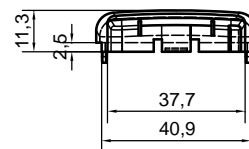
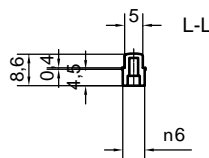
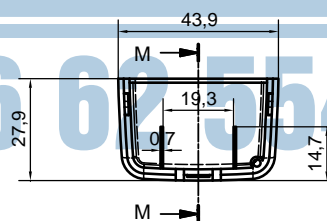
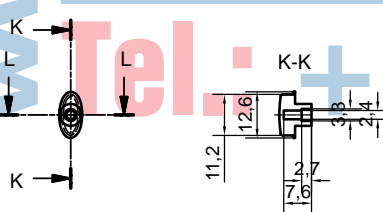

	Denomination	Assembly 11121		Part. Number	11121
	ENCLOSURES	Subject to technical modification without prior notice. Tipographical and other errors do not justify any claim for damages. All dimensions should be verified using an actual moulded part.			
	This document contains proprietary information TEKO S.p.a. and is tendered subject to the conditions that the information be retained in confidence not be reproduced or copied and not be used or incorporated in any product.			Rev. Index	Scale
				Date	Format design
			22/11/2005	1:1	A2