

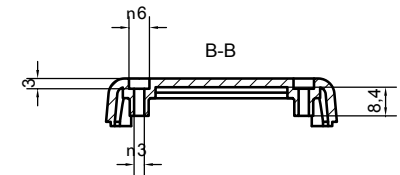

www.ret.hu

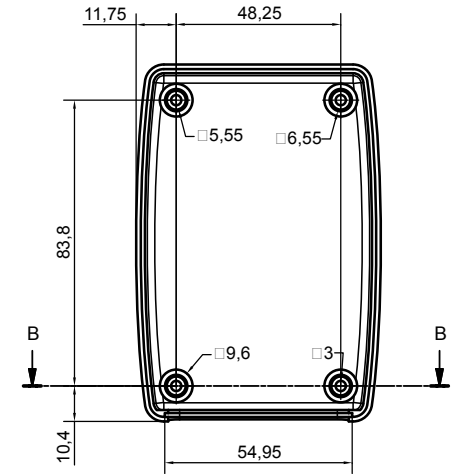

PCB MAX SIZE

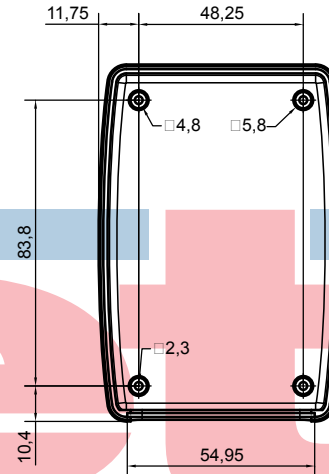
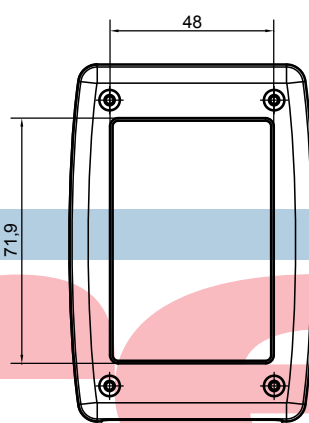
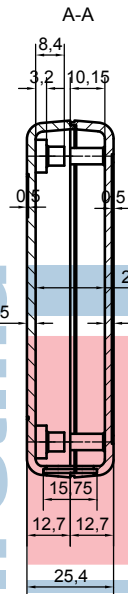
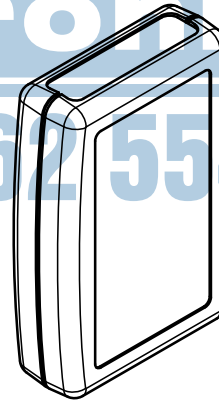
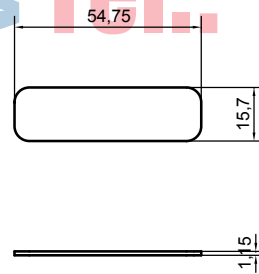
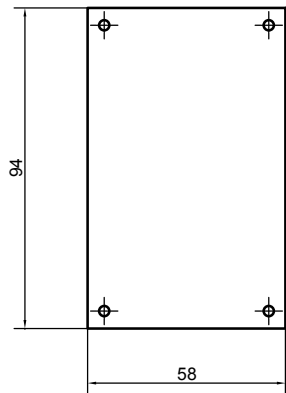

elektronika
Tel.: +36 62 554-600

 ENCLOSURES	Denomination Assembly HYP	Part Number HYP		
	Subject to technical modification without prior notice. Tipographical and other errors do not justify any claim for damages. All dimensions should be verified using an actual moulded part.			Rev. Index Scale
	This document contains proprietary information of TEKO S.p.A. and is tendered subject to the conditions that the information be retained in confidence not be reproduced or copied and not be used or incorporated in any product.			Date 26/09/2005
				Format design A2