

MAXIMUM PCB SIZE

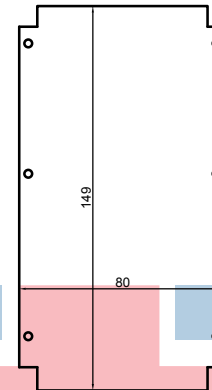

MINIMUM PCB SIZE

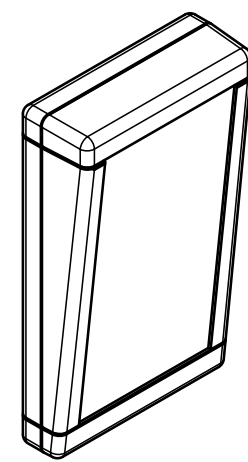
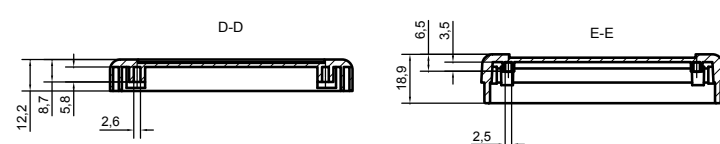
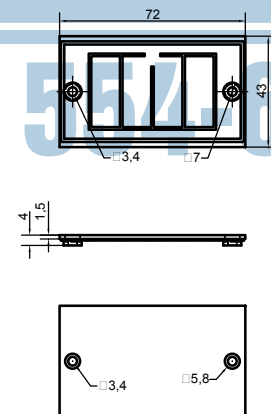
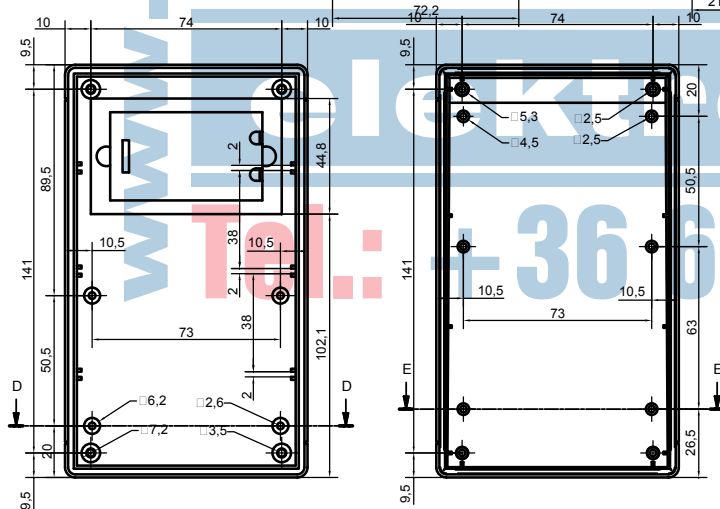
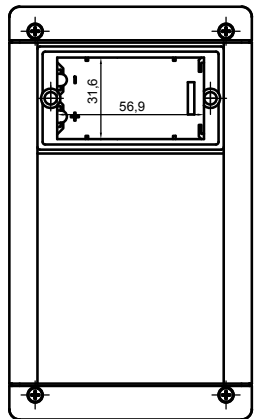
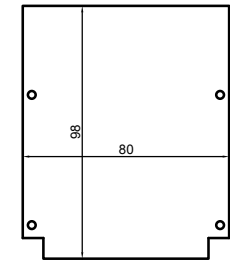

	Assembly TB-1SB		TB-1SB	
	<small>Subject to technical modification without prior notice. Tipographical and other errors do not justify any claim for damages. All dimensions should be verified using an actual moulded part.</small>			
<small>ENCLOSURES</small>	<small>Rev. Index</small>	<small>Date</small>	<small>Scale</small>	<small>Formal design</small>
	<small>18/05/2005</small>	<small>A1</small>	<small>1:1</small>	<small>A1</small>