

# R13-244

## Double Poles Of R13-112

T85

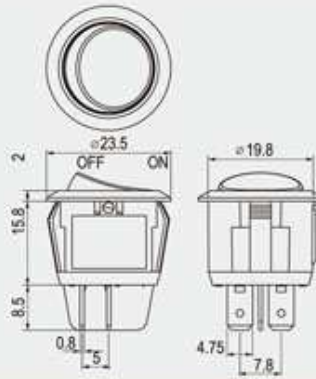

<b>Rating</b>	16A 125V AC/10A 250V AC 10(4)A 125 / 250V AC
<b>Contact resistance</b>	50mΩ Max
<b>Insulation resistance</b>	DC 500V 100MΩ Min
<b>Dielectric strength</b>	AC 1500V 1 minute
<b>Cut-out</b>	

### FEATURES

- \* MATERIAL: Frame is nylon (UL flame: 94V-2). Terminals are silver plated brass.
- \* Illuminated actuators are molded in PC, available with red, amber, green, blue and white colors.
- \* Snap-in mounting, easy to install switch into panel.
- \* Waterproof cover is optional.

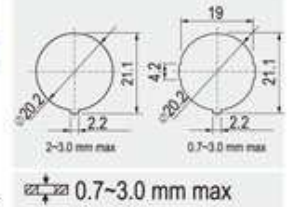

### Cut-out for X8 ROCKER

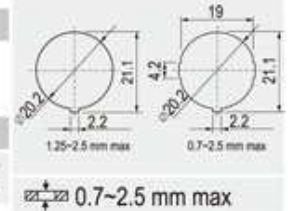

### ROCKER

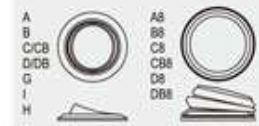

### Ordering number instruction

R13-244 [ ] - [ ]

#### FUNCTION

#### TERMINAL

#### Different position / Illuminated button (動作特性不同/帶燈)

0 2 .187" SQ

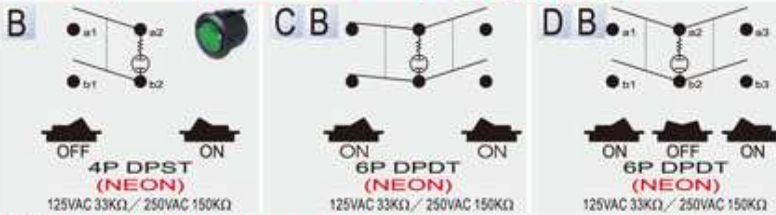

#### Different position (動作特性不同)

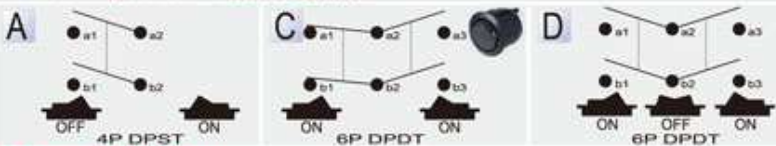

#### Momentary (彈回)

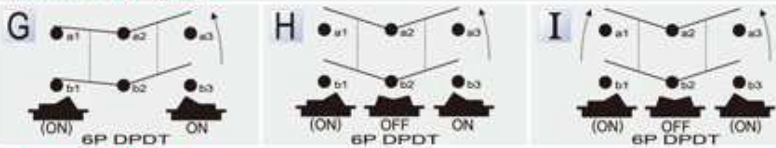

#### Waterproof (防水)

